

Data Sheet



Article number: 2032100M20125A1U

Description: E+G levelling foot
GN 32-100-M20-125-A1-U

Note: U Without nut, Hexagon socket at the top, Wrench flat at the bottom

Measures

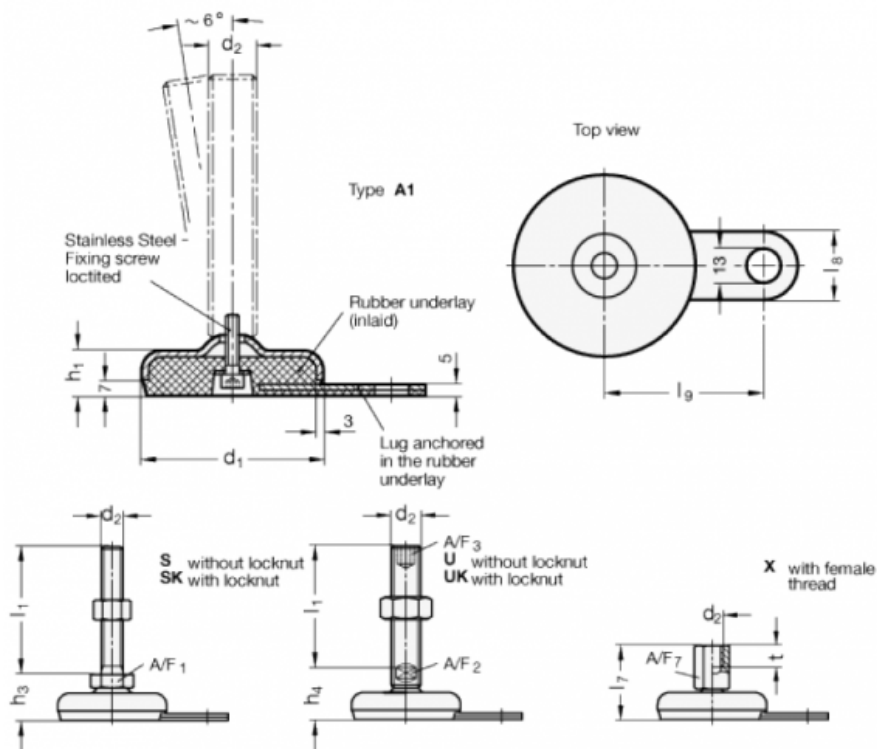

A/F2 = 15

l9 = 80

A/F3 = 10

d1 = 100

d2 = M20

h1 = 21

h4 = 36

l1 = 125

l8 = 30